

Article number: 20343232M863KR

Description: E+G Levelling foot
GN 343.2-32-M8-63-KR

Note: 0

Measures

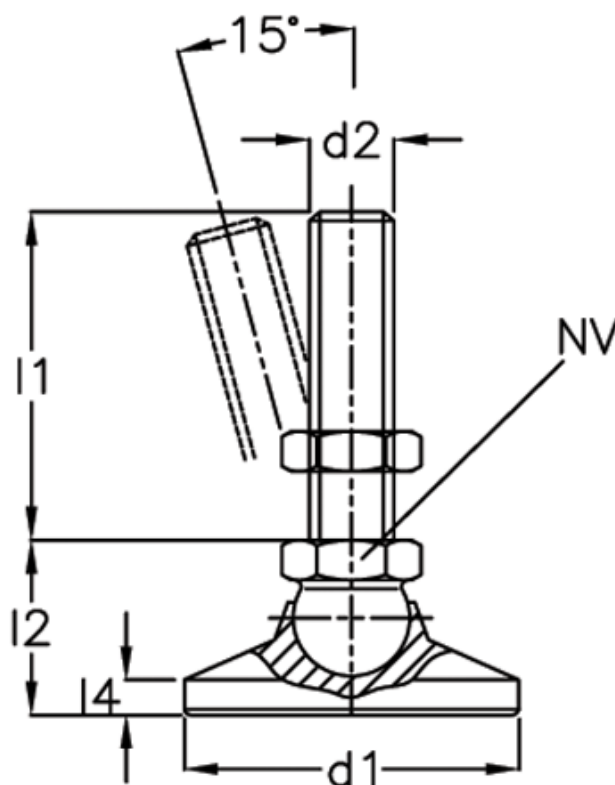

d1 = 32

d2 = M8

l1 = 63

l2 = -

l3 = 24.5

l4 = -

l5 = 6.5

NV = 12

Static load = 10

Weight in (g) = 67